



OKLAHOMA
Transportation

Outdoor Advertising Control
200 N.E. 21st Street
Oklahoma City, OK 73105-3204

April 2, 2024

Summit Locations LLC
ATTN: Samia Noman
311 East St.
Gordon, OH 45304

Application For Sign Registration
West side of US-62, Muskogee County
Property Owner: Taber INC

Dear Mrs. Noman:

Pursuant to our discussion, the enclosed application has been rejected and a Credit Voucher in the amount of \$100 has been issued, due to the location being within 500ft. of a playground.

We are returning the documentation submitted with the application and voucher. Please return the original Credit Voucher when you return the application documents.

Please call our office if you have any questions. (405)521-3005

Respectfully,

A handwritten signature in blue ink, appearing to read "T. Davis".

Thomas Davis
Transportation Supervisor
Outdoor Advertising Control Branch

Enclosures



Credit Voucher No. 325

(This voucher can only be redeemed for fees required by the
Outdoor Advertising Control Branch of ODOT.)

ISSUED TO: Summit Locations LLC

AMOUNT ISSUED: \$100.00

**REASON FOR ISSUE: Refund of Permit Application fee
location within 500 ft. of a playground.**

4-2-2024
Date

Kellie Perkins
Kellie Perkins
Outdoor Advertising Control
Okla. Dept. of Transportation

**OKLAHOMA DEPARTMENT OF TRANSPORTATION
APPLICATION FOR SIGN REGISTRATION & PERMIT
(See back of form for instructions.)**

ok-34

FOR OFFICIAL USE ONLY		
MGR. INITIALS	3707 OWNER NO.	REG. NO.
\$100.00 FEE AMOUNT	APPLICATION NO.	SIGN FILE NO.

OAC 3/26/2024

Part I - SIGN OWNER INFORMATION

101 Applicant's Name: Summit Locations LLC 102 Address: 311 East Street
 103 City: Gordon 104 State: OH 105 Zip Code: 45304
 106 Telephone No. (856) 639-4212 107 Fax No. () 108 Email Address: samia@summitlocations.com

Part II - LOCATION OF SIGN SITE

201 Located on Hwy.: HWY-62 202 Side of Hwy.: W 203 County Name: Muskogee 204 City Name: Muskogee
 205 Nearest Intersecting Hwy.: HWY-64 N S E W 206 Direction from Intersection: N 207 Distance from Intersection: 0.67 Miles & Tenths 208 Distance from Right-of-Way: 35 Feet
 209 GPS Coordinates: Latitude: 35 7564737801 Longitude: -95 3648788172

Part III - LAND OWNER INFORMATION (No. Assigned: 17731)

301 Land Owner's Name: Taber Inc. 302 Address: 6161 W 820 Rd.
 303 City: Fort Gibson 304 State: Ok 305 Zip Code: 74434
 306 Telephone No. (918) 869-8831 307 Have you enclosed proof of land use consent? YES NO

Part IV - PHYSICAL DESCRIPTION OF SIGN

401 DIMENSIONS: Height of Facing: 8 ft. (Cannot exceed 25 ft.) Width of Facing: 20 ft. (Cannot exceed 60 ft.) Overall Height Above Ground: 37 ft. (No limit by state)
 402 TYPE OF SIGN: Single Side-by-Side Stacked V-Type (Cannot exceed 30 ft.) Back-to-Back Tri-Vision (Rotating Slats)
 403 NO. OF PANELS: 4 (Advertising Displays) 404 WILL SIGN BE ILLUMINATED? YES NO If yes, will it be an LED/digital display? YES NO

Part V - ZONING AND COMMERCIAL/ INDUSTRIAL QUALIFICATIONS (One of these options is required for Class A Permit. However if applying for a Class C (informational) Permit, this section does not apply.)

ZONED AREA ONLY 501 - Is proposed location zoned? YES NO (If answer is no, then go directly to Item 505.)
 502 - What is the zoning designation? C-3 (Must be some type of commercial, industrial or business designation.)
 503 - Who is the zoning authority? Christy Riley- Permit Tech
 504 - If the area is zoned, a Zoning Confirmation from must be completed and attached. (Form OAC Z-504 or its equivalent.) zoning map attached
UNZONED AREA ONLY 505 - Is proposed location within 600 ft. of a conforming business? (Refer to OAC §730:35-5-12[a][2]) YES NO
 506 - What is the name of the business?
 507 - Please attach a diagram depicting the layout of the business and the proposed sign site.

Part VI - ACKNOWLEDGMENT

Have you read all of the statutes and regulations pertaining to outdoor advertising control? YES

REMARKS:

Inspector Pre-review:

STATE OF: Ohio
 County of: Darke
Jessica Wise/Samia Noman being of lawful age and first duly sworn upon oath deposes and states the following:

I, on behalf of myself (or) as authorized representation of the organization listed above as Applicant, so attest that I have read the foregoing information and that the facts set out therein are true and correct to the best of my knowledge and belief.

Signature of Applicant: Jessica Wise
 My Commission Expires June 29, 2027
 Printed Signature: Samia Noman

NOTARY PUBLIC:
 Subscribed and sworn to me this 21 day of March, 2024
 My commission expires: 06/29/27
Jessica Wise
 Signature of Notary

STANDARD GROUND LEASE AGREEMENT

THIS LEASE AGREEMENT made this 12th day of December 2023 by and between Taber Inc (hereinafter "Lessor," whether one or more), and SUMMIT LOCATIONS, LLC (hereinafter "Lessee"), a limited liability company organized under the laws of the State of Ohio.

WITNESSETH:

WHEREAS, the Lessor is the owner of a parcel of real property located on the North side of Main St. and commonly known as 701 N. Main St, Muskogee, OK 74401 and also known by the Parcel Number: 510003524; and

WHEREAS, said Lessor and Lessee desire to execute a Lease Agreement pertaining to a portion of said real property as further described in Exhibit A, attached hereto; and

WHEREAS, this instrument embodies the entire agreement between the Lessor and the Lessee concerning this transaction.

1) **DESCRIPTION OF LEASED PREMISES.** In consideration of the rent provided for in Paragraph 3 of this Lease Agreement, Lessor leases to Lessee a portion of the real property described above belonging to Lessor ("Lessor's Property"). The portion of the Lessor's Property subject to this lease is more fully set forth in Exhibit "A" to this agreement, which is attached hereto, and is incorporated by reference as if fully set forth herein (the "Leased Premises").

2) **TERM.** The term of this lease is 25 years; and shall commence on the date construction of the structure is completed. Lessee shall have the right to extend this Lease as set forth in Paragraph 12 below.

3) **RENT.** Lessee shall pay Lessor a quarterly rent in the amount of 17% of the actual gross advertising rent revenue of the sign. Rent shall be considered tendered upon due mailing to Lessor at the address set forth below, or at such other address as Lessor may have provided to Lessee in writing hereunder.

4) **USE OF PROPERTY.** Lessee shall use the Leased Premises for the erection, operation, and maintenance of outdoor advertising structures and for no other purposes. Lessee shall have the right to erect, place, maintain, convert to digital and/or replace advertising sign structures and equipment therefore on the Leased Premises and to post, paint, illuminate and maintain advertisements on such structures. Lessee shall further have the right to utilize an existing electrical connection or install electrical lines across Lessor's Property to the Leased Premises, for the purpose of lighting or otherwise operating the outdoor advertising structures. All costs incurred in obtaining electrical service on the Leased Premises for Lessee's use, including electrical bills and any construction or installation that is necessary, shall be paid solely by Lessee. All construction shall be performed by Lessee or by others at Lessee's request and shall be performed at Lessee's sole cost and expense. If Lessee is unable to obtain all necessary licenses, permits, and other necessary authority for the erection or maintenance of such sign, Lessee shall have the unconditional right to terminate this Lease Agreement upon thirty (30) days written notice as set forth in this agreement.

5) **OWNERSHIP OF IMPROVEMENTS.** All improvements placed upon the Leased Premises by Lessee shall remain the Lessee's property and may be removed at Lessee's discretion during the term of the Lease or within a reasonable time after expiration of the Lease. Any permits obtained by Lessee relating to the erection and/or operation of advertising structures on the Leased Premises shall also remain the property of Lessee.

6) **ACCESS TO LEASED PREMISES.** Lessor grants Lessee a non-exclusive easement over and across Lessor's Property at all times during the term of this Lease Agreement and any renewal thereof for the purpose of accessing, maintaining, replacing, repairing or performing work in connection with Lessee's advertising sign structures or for the purpose of providing utilities thereto. Lessor also grants Lessee the right to reasonably trim vegetation on Lessor's Property that threatens to obscure all or part of the view of Lessee's advertising sign structures.

7) **LESSOR'S COVENANTS.** A) **AUTHORITY TO ENTER INTO LEASE.** Lessor covenants that Lessor is the lawful owner of the Leased Property and has full and proper authority to enter into this Lease Agreement as such. B) **QUIET POSSESSION.** Lessor covenants that Lessee shall have quiet possession of the Leased Premises during the term of this Lease, subject, however, to the right of forfeiture and re-entry hereinafter provided for in the event of the Lessee's failure to perform its covenants and conditions hereunder. C) **NO OBSTRUCTIONS.** Lessor shall not maintain, place, or permit to be placed on Lessor's Property any signs, structures, vegetation, or other projection that would block or impair, in any way at all, the view of Lessee's sign structures from Main St.

8) **LESSEE'S COVENANTS.** A) **REPAIRS AND MAINTENANCE.** Lessee shall, at all times during the term of this Lease Agreement, keep the Leased Premises and all improvements placed thereon by Lessee in good repair, and shall maintain them at all times in a clean and attractive condition. B) **UTILITIES AND SERVICES.** Lessee shall, throughout the term of this Lease, pay all bills for electricity, other utilities, or other articles which may be caused by Lessee to be furnished or supplied to the Leased Premises, immediately upon becoming due and payable and shall hold the Lessor harmless from any liability therefor. C) **INSURANCE.** Lessee shall obtain and keep in full force and effect at all times during the term of this Lease Agreement, a policy of public liability insurance with policy limits in the amount of \$1,000,000 for the protection of Lessor and Lessee against liability arising out of Lessee's use of the Leased Premises and the improvements erected thereon. D) **BILLBOARD ADVERTISING CONTENT.** Lessee shall not display or permit to be displayed on the billboard any images or messages advertising, promoting, or condoning the usage of drugs, alcohol, tobacco, pornography, strip clubs, or any other such immoral or offensive behavior, whether such image or message should be expressed directly or by innuendo. E) **SURRENDER.** Within a reasonable time after the last day of the term of this Lease Agreement, Lessee shall surrender to the Lessor all of the Leased Premises in the same condition as when received, reasonable use and wear thereof and damage by fire, acts of God or war excepted, and remove the above ground portion of its structure.

9) **TERMINATION BY LESSOR.** If Lessee defaults in the payment of rent, or breaches any other covenant or condition of this Lease Agreement, upon the provision of written notice of the breach to Lessee and Lessee's failure to cure such breach within sixty (60) days thereafter, Lessor may, at Lessor's option, terminate this Lease Agreement for the default, reenter the Leased Premises, and require Lessee's removal of improvements placed on the Leased Premises by Lessee.

10) **TERMINATION BY LESSEE.** A) **BREACH BY LESSOR.** If Lessor breaches any covenant or condition of this Lease Agreement, upon the provision of written notice of the breach to Lessor and Lessor's failure to cure such breach within sixty (60) days thereafter, Lessee may, at Lessee's option, terminate this Lease Agreement for the default, and Lessor shall thereafter pay to Lessee any funds as are due to Lessee in addition to and not in lieu of other remedies available to Lessee for breach of contract. B) **OTHER CIRCUMSTANCES.** Lessee shall have the right to cancel this Lease Agreement upon thirty (30) days prior written notice to Lessor if any of the following occur: 1) Lessee's signs or structures on the Leased Premises are or become entirely or substantially obscured or destroyed through no fault of Lessee and Lessee chooses not to repair said signs, Lessee to make such determination within forty-five (45) days after the event causing the destruction or obscuration; failure to make such determination shall be deemed a waiver by Lessee of such right to cancel; 2) the Leased Premises is or becomes unsafe for maintenance of Lessee's signs or structures, through no fault, act or omission of Lessee; 3) a permanent diversion of change of traffic occurs along the street or streets adjacent to, or leading past the Leased Premises; 4) Lessee is prevented by a present or future law, regulation or ordinance from constructing or maintaining such signs on the Leased Premises. 5) The sign is no longer economically advantageous to the Lessee to operate.

11) **TRANSFER OF LEASED PREMISES.** A) **LESSOR'S SUCCESSOR.** If Lessor should sell or transfer the Leased Premises, the parties agree that any transferee shall be subject to the covenants and conditions herein contained, and binds the heirs, successors and assigns of the Lessor. B) **SPECIFIC PERFORMANCE.** Lessor and Lessee agree that the Leased Premises is unique and has particular value to Lessee for Lessee's business purposes. As a result, Lessor and Lessee agree that in the event of a transfer of the Leased Premises, the only appropriate outcome and the only adequate remedy is specific performance of this Lease Agreement. Lessor agrees to give any such transferee a copy of this Lease Agreement prior to transfer.

12) **EXTENSION.** This Lease Agreement shall extend for an additional term of 25 years after expiration of the term of this Lease Agreement under the terms and provisions set forth herein, unless the Lessee gives Lessor written notice of intent not to extend at least thirty

(30) days prior the expiration of the initial term. After the expiration of the initial term and automatic extension, this Lease Agreement shall further extend, year to year, until terminated by either party by providing written notice of intent not to extend at least thirty (30) days before expiration of this Lease Agreement.

13) **EFFECT OF CONDEMNATION.** In the event of condemnation of all or any part of the Leased Premises, Lessor grants Lessee the right to relocate Lessee's advertising structure on Lessor's Property in a location adjacent to the condemned property and/or adjacent to the street(s) or highway(s) from which the original sign structure was originally visible, if possible. This right is in addition to and not in lieu of Lessee's right to receive just compensation for the loss of its interest in the condemned property.

14) **ASSIGNABILITY.** Lessee shall have the right to assign all of Lessee's rights and obligations under this Lease Agreement without Lessor's prior approval. Upon such assignment, provided Lessee is not presently in default, Lessor, Lessee, and Lessee's assignee may execute a novation by which Lessee's assignee assumes, and Lessee is absolved of, any further duties, obligations, or liabilities pursuant to this Lease Agreement.

15) **NOTICES.** All notices to be given hereunder by either party shall be in writing and given by personal delivery or certified mail to Lessor or to the office of Lessee, and the date of any notice by certified mail shall be deemed to be the date of receipt thereof. All notices given under this Lease Agreement shall be sent to Lessee or Lessor at the address below.

16) **ACTUAL GROSS ADVERTISING RENT REVENUE.** This is defined as all rents collected from the advertisers, in the quarter for which rent is due under this Lease Agreement.

17) **MODIFICATION.** This Lease Agreement may only be modified or amended by a writing containing the valid signatures of Lessor and Lessee.

18) **CHOICE OF LAW.** The law of the state in which the Property is located shall govern. This Lease (and any addendum) represents the entire agreement of Lessee and Lessor with respect to the Structures and the Property.

19) **HEADINGS.** The heading notes as to contents of particular paragraphs herein are inserted only for convenience and are in no way to be construed as a part of this Lease Agreement or as a limitation on the scope of the particular paragraphs to which they refer.

20) **SINGULAR/PLURAL; GENDER.** Words of any gender used in this Lease Agreement shall be held and construed to include any other gender, and words in the singular number shall be held to include the plural, and vice versa, unless the context requires otherwise.

21) **SEVERABILITY.** Should any provision or portion of this Lease Agreement be deemed invalid or unenforceable by a court of law, then such portion shall not affect the enforceability of the rest of the Lease Agreement and shall be omitted from consideration with minimal effect on the enforcement of the remainder of the Lease Agreement.

22) **FIRST RIGHT OF REFUSAL.** During the term of this Lease Agreement and any renewals, Lessor shall (1) allow Summit Locations a First Right of Refusal to place billboard structures on any Lessor owned property.

23) **RECORDATION.** Lessee shall have the right to record this Lease Agreement, or memorandum thereof, at its own expense. Lessor shall cooperate with Lessee's requests for assistance.

24) **INTEGRATION.** This Agreement constitutes the entire agreement between the parties. Any modifications must be made in writing per Paragraph (17) above.

25) **ATTORNEY FEES.** Lessee is entitled to recover from Lessor any and all legal expenses, including all attorney's fees and/or expert fees, incurred to enforce its rights under this Lease Agreement.

LESSOR: Taber Inc

Address: 6161 W. 820 Rd, Fort Gibson, OK 74434

Phone: 918-869-8831

By: Mark Martin
Mark Martin

Date: Dec 12, 2023

















LESSEE: Summit Locations, LLC

Address: 311 East Street
Gordon, OH 45304

By: Joe Cala
Joe Cala, its General Manager

Date: Dec 13, 2023

Zoning Legend

	A – Agricultural		I-1 – Light Industrial
	R-A – Agricultural Residential		I-2 – Heavy Industrial
	R-1 – Single-Family		P – Port Industrial
	R-2 – Two-Family		CBD – Central Business District
	R-3 – Townhouse		PUD – Planned Urban Development
	R-4 – Multi-Family		PP – Public Property
	R-5 – Mobile Home		POS – Parks & Open Space
	C-1 – Local Commercial		
	C-2 – General Commercial		
	C-3 – Regional Commercial		

SW 23-15-18

NE 23-15-18

SW 24-15-18

NE 26-15-18

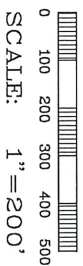
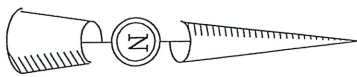

MAP INFO.:	SAN. SEWER	WATER
	STORM SEWER	ZONING
CITY OF MUSKOGEE		
P.O. BOX 187 / MUSKOGEE, OKLAHOMA 74401-0187 (315) 882-5602		
ATLAS		
SE 23-15-18		
SCALE: 1"=200'	DATE: 5/27/87	REVISED: 9/2/2021

Owner: Taber Inc **Address:** 701 N. Main St, Muskogee, OK 74401

Coordinates: 35.7564737801, -95.3648788172 **Parcel ID:** 510003524

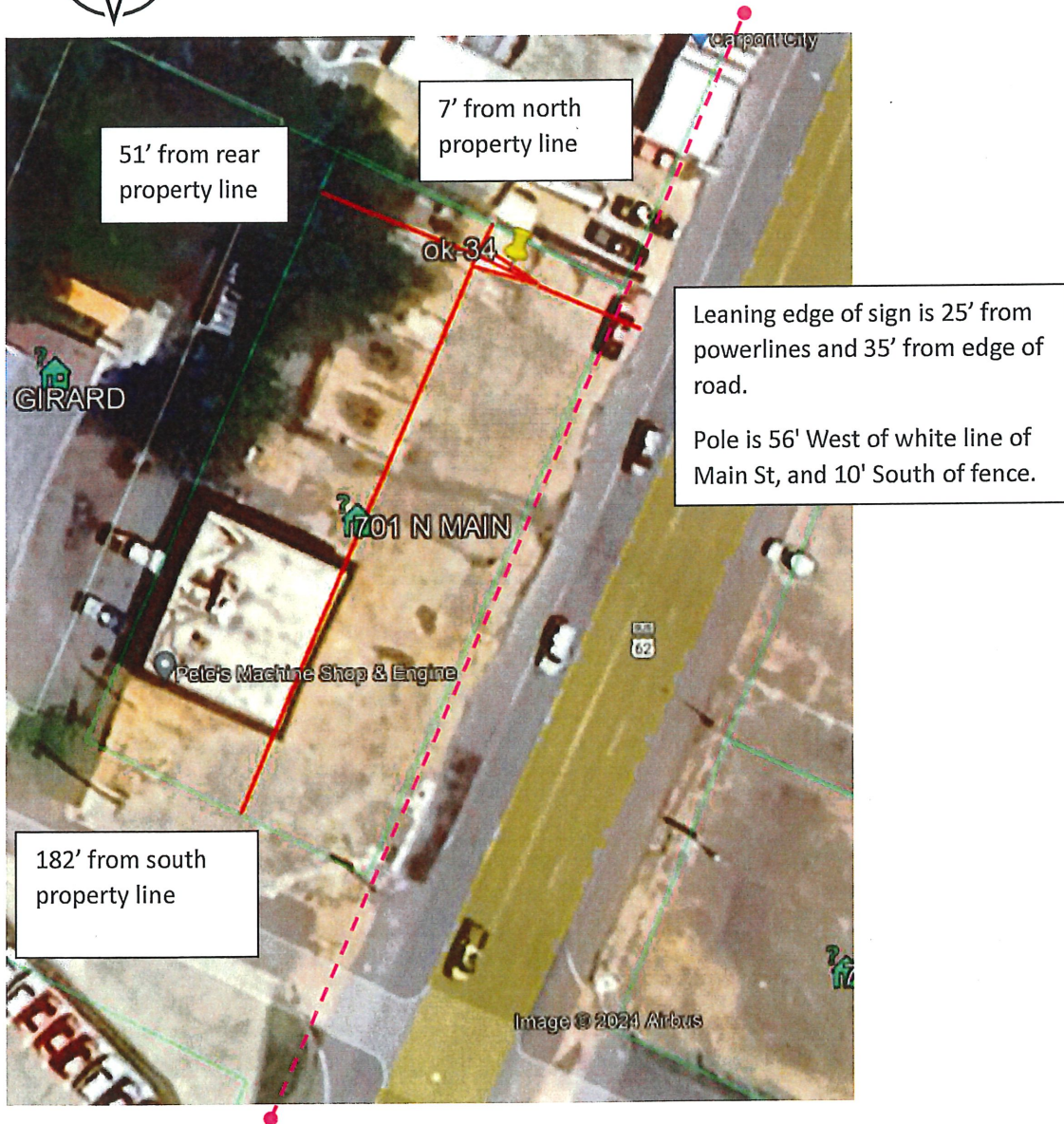

property line/row: 

Existing Power Line: 



12/19/2023
707 N Main St
Muskogee OK 74401



12/19/2023
707 N Main St
Mustoge, OK 74401





12/19/2023

707 N Main St

Muskogee, OK 74401

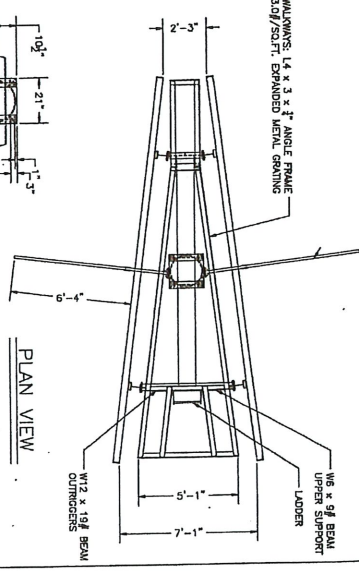
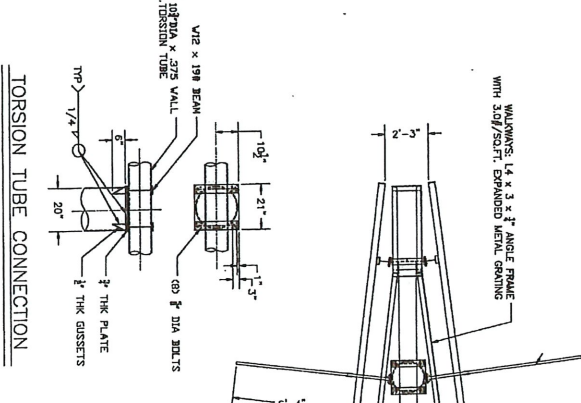
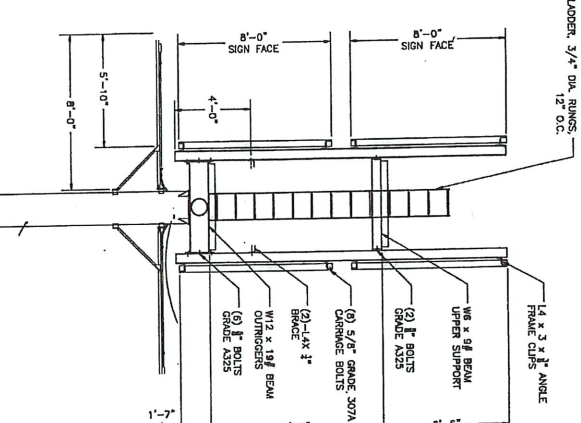
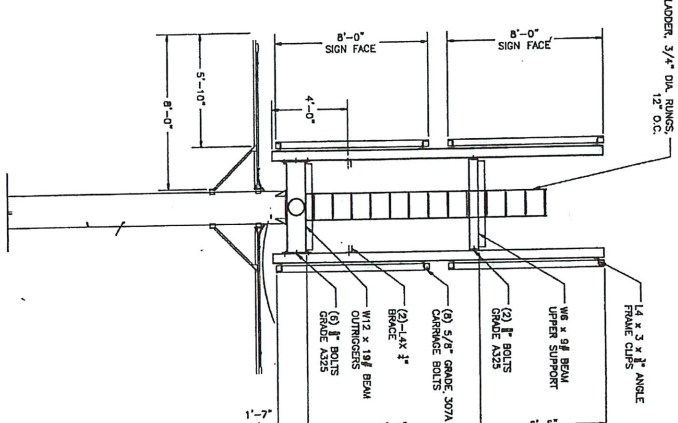
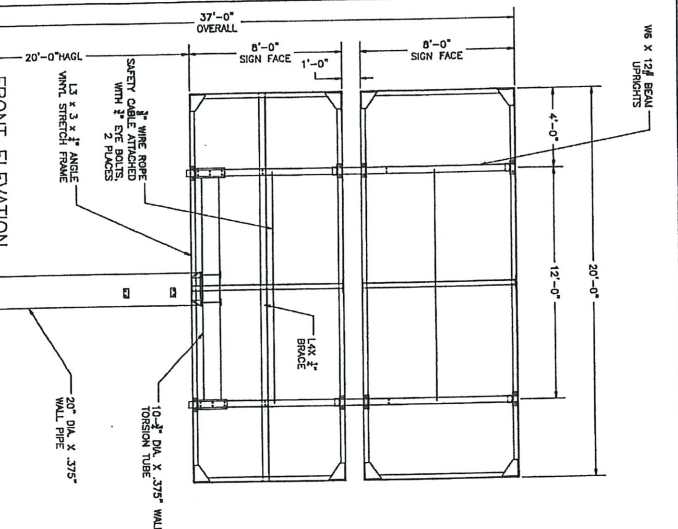
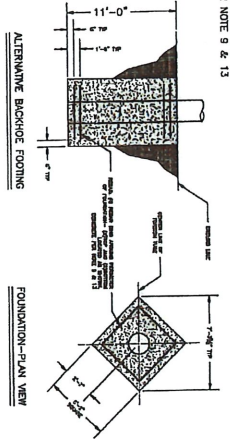
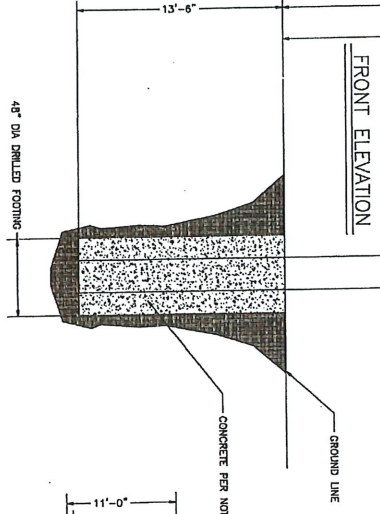

FRONT ELEVATION

TORSION TUBE CONNECTION

PLAN VIEW

SPECIFICATIONS

1. STEEL ROLLED W BEAM SECTIONS: ASTM A992
2. ALL OTHER ROLLED SECTIONS: ASTM A36
3. PIPE SECTIONS: A.P.I. 5L X 42
4. BOLTS: 1/2" MINIMUM DIAMETER-GRADE A325
5. ASSUMED LATERAL SOIL PRESSURE 200 PSF/FT.
6. SOIL BEHAVIOR PRESSURE ASSUMED 1800 LBS./SQ. FT. PER 2015 IBC
7. TABLE 1806.2
8. DESIGN WIND LOAD 24.44 P.S.F. THE DESIGN WIND LOAD HAS BEEN FOUND TO EXCEED THE SEISMIC LOADING OF EARTH QUAKES.
9. DEAD LOAD: TOTAL SIGN WEIGHT 8,200#
10. LIVE LOAD: WALKWAYS - 80#/SQ. FT.
11. CONCRETE: 3000 PSI AT 28 DAYS DESIGN-2500 PSI AT 28 DAYS
12. ALL WELDS TO CONFORM TO AWS D1.1-98 SPECIFICATION
13. DESIGN IN ACCORDANCE WITH BUILDING CODE OF IOWA - 2015 IBC W/AMENDMENTS REQUIREMENTS.
14. STEEL TO RECEIVE RUST INHIBITIVE PRIMER AND TOP COAT OF COLOR CHOICE
15. REINFORCING BAR: ASTM A-615 GRADE 60 (REBAR IS NOT REQUIRED IF FIBER REINFORCED CONCRETE IS USED).
16. STRUCTURAL COMPONENTS ARE CAPABLE OF RESISTING HYDROSTATIC AND HYDROLYMIC LOADS AND THE EFFECTS OF BUOYANCY
17. ALL STRUCTURAL CONNECTIONS SHALL BE WELDED 3/8" ALL AROUND UNLESS OTHERWISE NOTED.

CODE DATA

SUMMIT LOCATIONS

MONOPOLE 8' x 20'